



HF Transceiver

G90

Operation manual

Version 4.34 – October 2024 (for G90/S units with firmware v1.80).

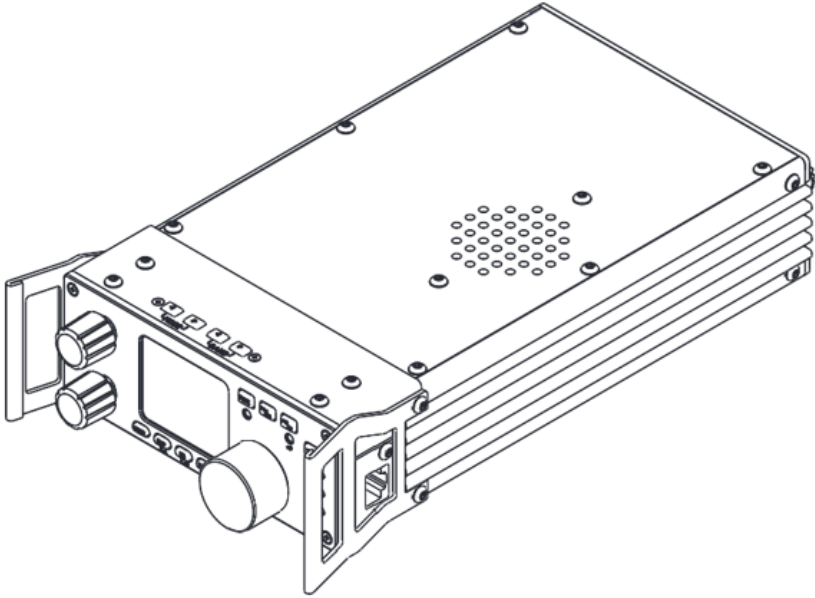

Ultra-Miniature 24 Bit SDR



Thank You for Shopping at Radioddity!
FIND TUTORIALS, SUPPORT AND MORE



<https://www.radioddity.com/>



<https://www.facebook.com/radioddity>



<https://www.youtube.com/c/Radioddityradio>

FC CE 06780  ROHS



About Radioddity

“You, our friend and customer, are at the forefront of what we do.”

Thank you for purchasing a XIEGU product from Radioddity. Through a strong partnership which allows us to bring you the latest technology from the XIEGU brand and on behalf of Customer Support team, we strive to fulfill our promise to better meet your needs every day.

In order to protect your rights please read the terms on XIEGU Warranty Card carefully and know the Warranty Policy.



FAQ



Facebook group.

G90 Feedback Survey : *scan to share your suggestions!*



We look forward to improving our products based on customer experience, and any ideas would be appreciated!

If you have any suggestions for new XIEGU products, you're welcome to contact us via < support@radioddity.com



XPA125B Amplifier



G90-H1 stand



DE-19 data interface



GNR1 Digital audio noise filter

Information on all of these and other accessories can be found at www.radioddity.com



Warnings

1. Please read this manual fully before operation so as to get a good understanding of the G90's capabilities and functions.
2. When using an external mains power supply or battery, carefully check the polarity of the power cord and do not reverse the polarity.
3. The warranty of this radio does not cover damage caused by an incorrect external power connection error or damage caused by improper power supply voltage.
4. Only qualified technicians shall service this equipment.
5. Do not tamper with the transceiver for any reason.
6. Do not operate the transceiver with a damaged antenna. If part of an antenna comes into contact with your skin, a minor burn can result.
7. Turn off your transceiver prior to entering any area with explosive or flammable materials.
8. Do not operate your transceiver in any area near explosive or flammable materials.
9. To avoid electromagnetic interference, please turn off your transceiver in any area where notices instruct you to do so.
10. Turn off your transceiver before boarding an aircraft; any use of a radio must be in accordance with airline regulations and crew instructions.
11. Turn off your transceiver before entering any blasting area.
12. Do not place the transceiver over any airbag deployment area in vehicles containing airbags.
13. Do not expose the transceiver to direct sunlight over a long period of time, nor place it close to any heat source.
14. When transmitting with the transceiver, hold the microphone 3 to 4 centimeters away from your lips and keep a safe distance away from the antenna in accordance with the ICNIRP and any additional local regulations.

Copyright

All rights reserved 2024 Chongqing Xiegu Technology Co., Ltd. Reproduction of any part of this manual is prohibited without permission.

We would like to extend sincere gratitude to Radioddity's ham friends -- Bob Nagy (AB5N), Garry F. Decker (W9WHF) and Ed Durrant (DD5LP), for their instructive advice and useful suggestions in this G90 English manual.



Introduction

The G90/S is an amateur radio portable 20W HF transceiver using the latest 24-bit SDR technology. Based on a 24bit-CODEC, the G90/S brings superior transceiver performance and a highly configurable user experience. The detachable head design allows you flexibility to position the radio's main body where needed. The radio includes a built-in high-performance ATU capable of matching a very wide range of antennas.

Features Include:

- High-performance RF front end giving superb selectivity
- Modes provided are LSB/L-D/USB/U-D/CW/CWR/AM/NFM
- 1.8-inch-high-contrast color TFT LCD display
- ±24k bandwidth spectrum & waterfall displays
- Adjustable DSP band filters (CW mode can be as narrow as 50Hz)
- Built-in CW Decoder
- Detachable head unit
- Built-in Antenna SWR scanner
- Built-in Wide-range automatic antenna tuner

Please read this manual carefully for a better experience and a full understanding of the operation of the G90/S.

- The /S is the version sold in the People's Republic of China. This operation manual is applicable to both the G90 and the G90/S models.
- In 2024 some minor hardware changes were made to the case of the G90. These included a change to the Anderson Powerpole system for the DC supply and the removal of the heatsink fins on the base of the unit, replacing them with cooling vents to allow a good airflow over the internal components. These changes do not affect how the radio operates and the model is still referred to as the Xiegu G90.

Note: As this is a “Software Defined Radio” many things can be changed with a firmware upgrade. New features can be added and the operational processes can be changed. Therefore, it is recommended that you ensure your G-90/S is at the latest firmware level (as of this update of the manual, that was Firmware v1.8 in the head unit released May 12th 2023 and with base unit firmware vers 1.79b03 released on October 26th 2022). If the instructions in this manual don't appear to work as expected on your G-90/S it is highly likely that you are on a different firmware version.



CONTENTS

About Radioddity.....	3
Warnings	4
Copyright.....	4
Introduction	5
Specifications	8
Accessories and optional components.....	10
Interface Definition.....	11
Machine Interface – Front panel.....	12
Machine Interface - Rear Panel.....	13
Machine Interface – Head Unit	14
Machine Interface – Remote Head Unit	15
Hand Microphone Buttons	16
Power Source Connection.....	17
Button Functions	18
Operation of a button’s second function:.....	19
Screen Display Icons.....	19
Function and definition of displayed icons:	20
Operation	21
Transceiver start and shutdown	21
To turn off the LCD screen to save power:	21
Display of Power Voltage:	21
Selection of Working Frequency Range.....	22
Operating Mode Selection	23
Volume adjustment.....	23
Call Sign Editor.....	24
Setting Operational Frequency.....	24
Adjustment of RF Gain and Muting Level	25
Squelch Operation (prior to firmware v 1.75):	26
Multi-function Adjustment Knob (from F/W version 1.75 onwards).....	26



Reception and Transmission Operations using SPL and VFOA/B	27
Automatic Gain Control (AGC)	28
PRE-AMP/ATT (combined control)	29
Pulse Interface Suppressor – Noise Blanker.....	29
Voice Compression CMP	30
CW (Morse Code) Communication	30
CW Keyer settings	31
SSB Voice Communication	32
Voice-controlled Transmit - VOX.....	33
Setting Line level Input into ACC connector:.....	33
Automatic Antenna Tuner.....	34
Standing-wave Scanner SWR	34
Corresponding location of keys VS. screen labels:	35
Fine Tuning of Received Frequency (RIT).....	35
Line Input and Output.....	36
Operation of line output:	36
Channel Memory Write (MW) and Clear (MC)	37
Transmitter Power Setting.....	37
Digital (DSP) Filters (from FW version 1.79b02 onwards)	38
Receive filter operation prior to firmware v 1.79b02:.....	39
Spectrum/ Waterfall Display	40
Data Communication.....	41
Cable connection steps.....	42
Digital Mode Connections	43
Factory Reset.....	45
System Menu	46
CiV Control Instructions	49
Band Voltage Data	51
Firmware upgrades.....	52



Specifications

General parameters

Frequency range:	RX: 0.5MHz-30MHz TX: 1.8-2.0MHz (*1) 3.5-4.0MHz (*1) 5.330.5-5.405MHz (*1 *3) 7.0-7.3MHz (*1) 10.1-10.15MHz 14.0-14.35MHz 18.068-18.168MHz 21.0-21.450MHz 24.89-24.99MHz 28.0-29.7MHz
Operating modes:	USB/U-D/LSB/L-D/CW/CWR/AM/FM (*2)
Minimum step:	10Hz
Antenna impedance:	50Ω
Working temperature:	0°C ~ +50°C
Frequency stability:	±1.5ppm in the 10~60min after startup @25°C: 1ppm/hour
Power supply voltage:	10.5~16.5VDC, negative ground
Current consumption:	Receive: 700mA@ Max Transmit: 6A@ Max
Case size (mm):	120Wx45Hx210D (case only) 140Wx52Hx250D (with handles)
Weight:	About 1.63kg (for main body)

Transmitter parameters

RF output power: (@ 13.8VDC)	20W(SSB/CW/FM/AM)
Spurious suppression:	≥50dB
Carrier suppression:	≥40dB
Microphone impedance:	200Ω ~10kΩ (most often 600Ω)



Specifications (continued)

Receiver parameters

Circuit type:	Zero-IF (ZIF) direct conversion SDR.
Neighboring channel suppression:	≥60dB
Sideband suppression:	≥60dB
Sensitivity:	

	SSB/CW	AM
0.5~1.79999MHz	/	10uV
1.8~1.99999MHz	0.35uV	10uV
2.0~27.99999MHz	0.25uV	2uV
28.0~30.0MHz	0.25uV	2uV

Measurements made with PRE=on, ATT=off, NB=off, SSB/CW/AM=10dB S/N.

Mirroring suppression: 70dB

Sideband suppression: 60dB

Audio output: 0.5W (8Ω, ≤10% THD)

Audio output impedance: 4~16Ω

◆ The specifications above may be changed without notice.

◆ (*1) The operator is ALWAYS responsible to ensure he/she does not transmit using the radio outside of the amateur allocation (and in the case of an amateur without a full authority licence (i.e. entry level or novice) outside of the allocated frequencies in their licence). Radios that are sold to service the international market may at times have the ability to transmit on frequencies that are not available in some countries or under some licence classes. You as the operator MUST ensure that you do not transmit outside of your authorized frequency range (do not forget about the sideband(s) when operating close to the edge of a band).

◆ (*2) FM mode was only fully available from version 1.75 of the firmware prior to that firmware version it was only available in conjunction with XIEGU's GSOC controller. The two data modes U-D and L-D were added in FW v 1.79b02

◆ (*3) The G90/S covers the range needed for the US 60m channels and the WRTC15 ITU band. It does not cover the bottom half of the UK 60m "bandlets"



Accessories and optional components

Included accessories:	Quantity
Multi-function hand microphone	1
USB data interface cable:	1
DB9 head unit extension cable:	1
Detachable head fixing studs	2
Hexagonal wrench	1
DC power cord	1
Warranty card	1
Instruction leaflet	1
Quality assurance certificate	1

*Optional accessories:

DE-19: Digital interface unit providing one USB cable to the PC with support for two-way audio and serial communications as well as providing control of an optional XPA125B amplifier.

XPA125B: Xiegu 100W power amplifier, including an automatic antenna tuner.

GSOC: external, large screen, controller.

G90-H1: Stand with fan

G90-H2: Tilting front support legs

PAX-100: Radioddity HF 100W PEP amplifier.

GNR 1: Xiegu Digital Audio Noise Filter Unit.

NOTE: The G90/S is dealer modifiable for use on the US MARS required transmit frequency ranges.

NOTE: Your antenna will have a great impact on the quality of your communications. Many simple wire antennas offer excellent performance for field operations.



Interface Definition

Wiring of microphone socket (looking from the outside of the radio)

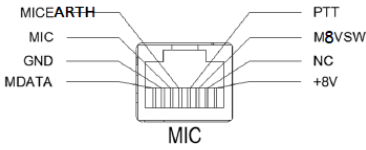

Wiring diagram of COMM plug

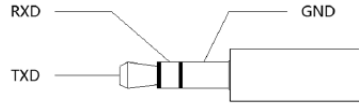

Wiring diagram of earphone plug

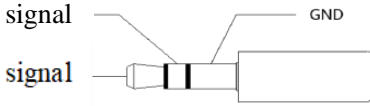

Left and right connections carry monaural audio

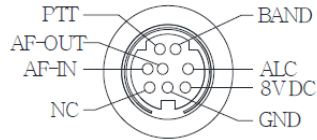

Rear ACC socket

Wiring of CW keys

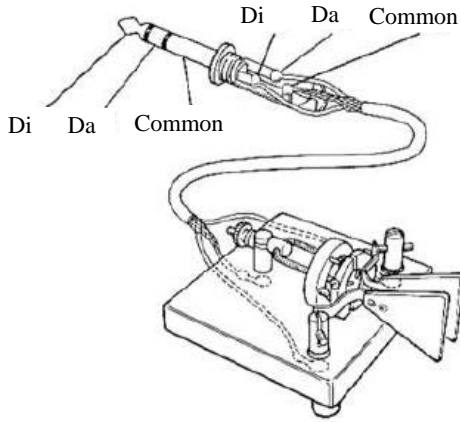

Note:

◆ If the connector of the CW key is a 6.5mm 2-wire plug, please change it to a 3-connector 3.5mm stereo plug according to the wiring method shown in the figure above.

◆ Be careful when using 2-core to 3-core adapters because incorrect wiring may put the radio into CW transmission mode all the time.



Machine Interface – Front panel

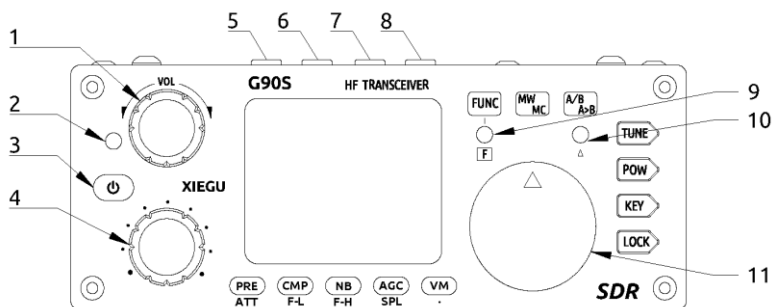

1 Volume knob

- Turn the knob to increase or decrease the volume.
- A momentary press alternates between headphone/speaker output.

2 Power supply /transceiver indicator light

- Standby /receive state: yellow-green;
- Red indicates the radio is transmitting.

3 Power (on/off) switch

- When powered-off, a momentary press of this button will turn the radio on.
- When powered-on, a long press of this button will shut down the radio.
- While starting up, a momentary press of the button will turn off the screen to save electricity.

4 Multi-function Adjustment Knob

- By default, turning this knob will change the frequency in 100kHz steps.
- A long press of this knob will select custom action functions.

5-6 MODE switching

Pressing these buttons will cycle through all the modes.

7-8 BAND switching

Pressing these buttons will switch up or down through the Amateur bands or the Amateur and SW Broadcast bands. Whether the SW Broadcast bands are included in the sequence is defined through Function 8 in the System menu. (Transmission is only allowed in the HAM bands).



9 FUNC indicator

This LED will light when the second function of a button is activated.

10 Δ F indicator This LED blinks when the CW signal is tuned in when in CW mode allowing the CW decoder to work.

11 Main VFO/Mem tuning knob

Change the current frequency by rotating this knob. When setting menu items this knob changes the parameter's value.

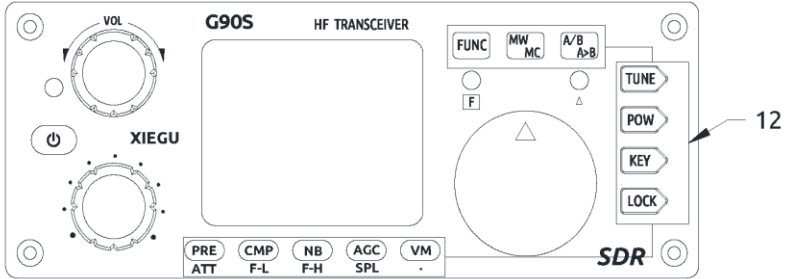

12 Function keys

The definition and functions of these buttons are detailed in the operation section of this manual (Pages 18-19).

Machine Interface - Rear Panel

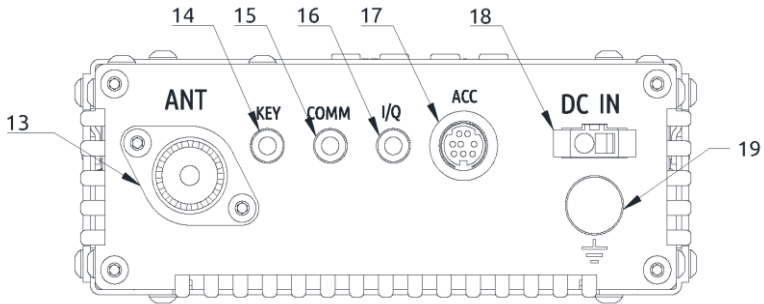

13 Antenna interface

SO-239 type - impedance 50Ω.

14 KEY interface

A 3.5mm stereo jack used to connect manual/paddle CW keys. (See Page 10 for the wiring details)



15 COMM interface

Only used for updating the radio body's firmware at present.

16 I/Q signal output port

A 3.5mm connector (3 wires) used for IQ signal output.

17 ACC interface

See the interface details on page 10.

18 DC power interface

DC power input (PSU or battery). The round hole is the negative connection and the square hole is the positive connection. Note: as of mid-2024, this power socket has been replaced with an Anderson Powerpole® version

19 Ground terminal

Good grounding can improve the receiving and transmitting performance of the G90/S and reduce the possibility of RF ingress.

Machine Interface – Head Unit

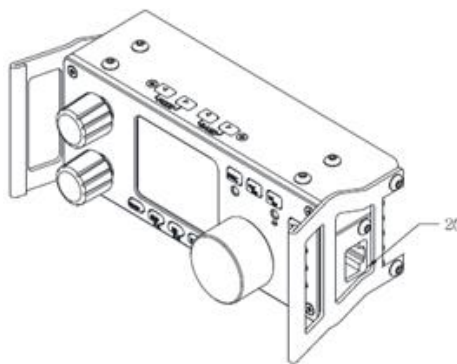

20 MIC (microphone) interface (located on the right-hand side)

Used to connect the included multi-function handheld microphone.

21 Headphone interface (located on the left-hand side)

This is a 3.5mm stereo connector (3 wires) used to connect earphones. (See Page 11 for the wiring details). **DO NOT USE A MONO PLUG, it will short the audio to earth.**



22 Communication interface (located on the left-hand side)

Used for updating the Firmware of head unit and providing a CAT control interface to your computer.

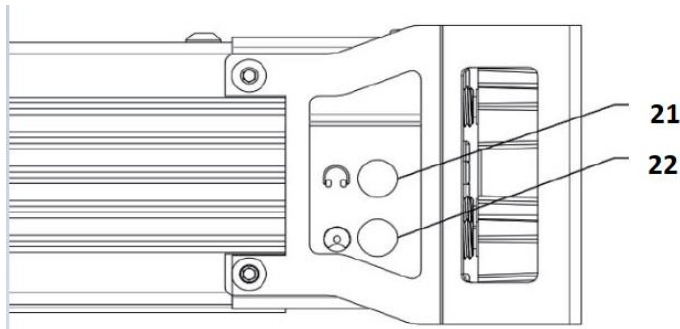

Notes:

1. Insert the supplied 3.5mm to USB cable into this port for data transfer or CAT control mode communications.
2. Do not insert the cable into this port before you start the G90/S up.

Machine Interface – Remote Head Unit

When mounting the head unit away from the base unit, **ONLY** use the supplied extension cable. This is a specific cable designed for this use made just for this purpose. Owners have reported that using a different (similar looking) cable from other sources are suspect in creating internal damage to the head unit. If you require a longer cable, contact the retailer where you bought the radio (Radioddity) for assistance of what is possible.



Hand Microphone Buttons

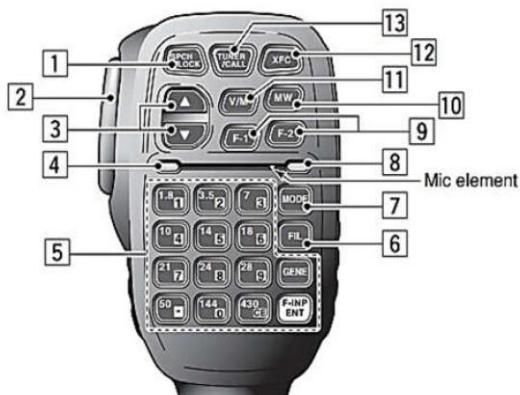

- | | |
|--|---|
| 1. LOCK button | Lock button |
| 2. PTT button | Press to transmit |
| 3. Up/down | Frequency increase/ decrease button (user-defined in the system menu) |
| 4. Transmit/receive indicator light | Transmission in progress indicator light |
| 5. Main keypad area | Main numeric keypad area |
| 6. FIL button | Filter selection (no action on DSP filter) |
| 7. MODE button | Selection of the operating mode of the radio
Lights whenever a key is pressed on the microphone. |
| 8. Functional indicator light | F1/F2 buttons (user-defined in the system menu) – e.g. preamp / split. |
| 9. Function buttons | Memory channel operation |
| 10. MW button | Frequency/memory channel switch. |
| 11. V/M button | <i>No function</i> |
| 12. XFC button | Momentarily pressing this button will switch the ATU in or out of circuit. Pressing in for a longer time starts automatic antenna tuning. |
| 13. TUNER button | |



Power Source Connection

Connect your power supply or battery to the DC-IN connector. Current capability of the DC power supply should be at least 8 amps. Batteries should supply 10.5-16.5V DC and have capacity to supply up to 10 amps. Typical current requirements on transmit are generally less than 8A. Use the provided cable to connect the G90/S to your DC supply. The G90/S transmitter is designed in such a way that dropping supply voltage from a weak battery has little effect on the transmitter output power until 10.5v is reached.

The DC power supply must be connected in strict accordance with the following figure to avoid a reverse polarity connection.

◆ The red wire must be connected with the positive pole of power supply and black wire to the negative pole of the power supply.

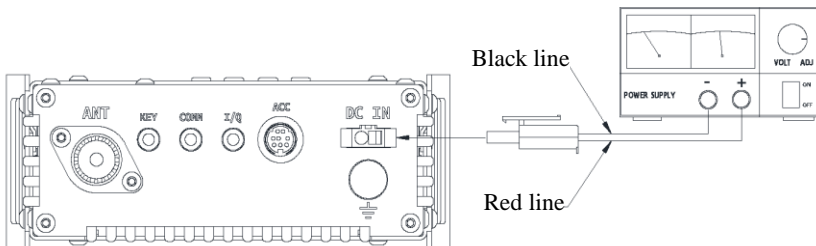

◆ A Ferrite Choke may be attached to the power wires to prevent external RF from entering the radio via its power lines and RF interference from inside the radio from radiating externally via the power cable. When installing a ferrite choke, place it closest to the radio end of the DC cable.

◆ **Polarity of power cables should be checked carefully to avoid reverse polarity when connecting your power supply or battery.**

◆ **Although the G90/S has reverse polarity protection reverse connection of power should be avoided.**



Button Functions

Button	First function (momentary press, cycle)	Second function (FUNC+) (quick press so light comes on)	Long press
PRE/ATT	PRE - ATT - Normal. cycles through these states.	/	/
CMP/F-L	Turn on voice compression	Digital filter F-L, low-pass cut-off frequency selection using the main tuning knob	Reset filter parameters
NB/F-H	NB ON-NB Level-NB Width	Digital filter F-H, high-pass startup frequency selection using the main tuning knob	Reset filter parameters
AGC/SPL	AGC, Fast-Slow-Auto-none.	Turn on the split frequency transceiver operation mode	RF GAIN
VM	Switch between frequency and channel mode.	/	Call Sign Editor
MW/MC	Write channel to memory.	Clear channel entry	/
A/B. A>B	Switch between VFO-A and VFO-B	Copy the current VFO-A frequency to VFO-B.	/
TUNE	Turn on/off the antenna tuner (in-circuit/out-of-circuit)	/	Antenna tuning
POW	POWER Power output setting	MICGAIN Hand microphone MIC gain setting	Standing-wave scanner display
	SWR THR Standing-wave protection threshold setting	INPUT Audio input selection	
KEY	SPEED Automatic key rate setting	CW Volume Side tone volume setting	CW automatic decoder
	M/L/R Manual/automatic left and right mode switching	CW TONE Side tone frequency setting	
	MODE iambic A/B mode switching	/	
	QSK Insert/non-insert selection	/	
	QSK Time Hang time setting	/	
	Ratio Setting of the automatic key dot-and-dash interval ratio	/	
LOCK	Lock / Screen brightness.	SCALE Spectrum reference level setting	Lock button
		AVE FFT Mean value setting, ranged 1~10	
Volume knob (press)	Loudspeaker / earphone switching	VOX ON/OFF Voice control switch	/
		VOX GAIN Voice control gain setting	/
		ANTI-VOX Hand microphone and speaker echo suppression setting	/
		VOX DLY Voice control transmission turnoff delay	/
Multi-knob (press)	Filter center mode setting	/	/
	Filter bandwidth mode setting	/	/
Main knob (press)	Accept (save) settings	Activate RIT	/



Operation of a button's second function:

Press the [FUNC] button - the F indicator LED will illuminate, then press the required function's button.

Press the [FUNC] button again to exit the secondary function. At this time, the F indicator LED will go off.

Pressing the [FUNC] button for 1-2 seconds will take you into the System Menu (see later in this manual for details of parameters that can be set).

■ In any function (including the secondary FUNC setting) a short press of the main knob will save the setting. This will also exit the function setting mode and return you to the main interface.

Screen Display Icons

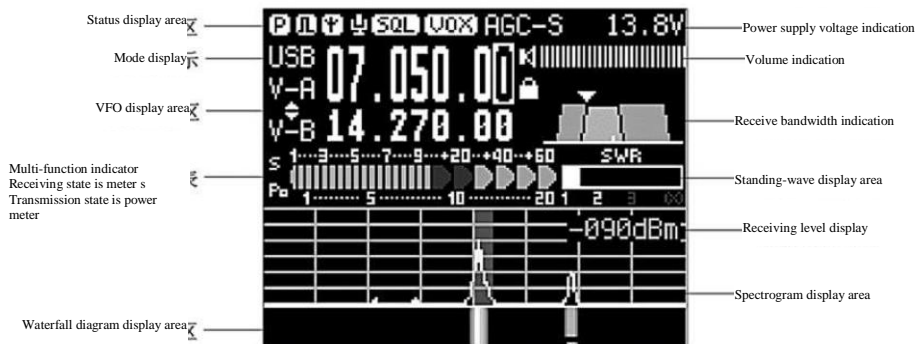



Function and definition of displayed icons:

[P]: pre-amplifier is ON. The icon character A indicates that the attenuator is in-line. No character indicates Normal mode.

[N]: noise blanker is ON

[A]: automatic antenna tuner is in circuit.

[C]: voice compression CMP is active

[SQL]: squelch is ON

[VOX]: voice triggered TX control function is ON

[AGC-S]: AGC control is set to Slow (alternatively AGC-F, AGC-AUTO, AGC settings may be indicated)

13.8V: supply voltage display.

USB: Current operating mode in use – USB, LSB, CW, CW-R, AM or FM.

V-A
V-B: As the split mode symbol is indicated between VFO-A and VFO-B, VFO-A is the current receive frequency and VFO-B is the transmitting frequency. Without the “Split” indicator the text VFO-A and VFO-B indicate the frequencies of the two VFOs.

[S]: SPL split frequency receiving & transmitting mode is active.

[M]: Loudspeaker mode. A short press-in of the volume knob switches between earphone and speaker modes.

[L]: All buttons locked symbol – settings cannot be changed until the buttons are unlocked again.

: While receiving, the received signal strength is indicated by the green/red line and can be read off against the top row of figures. When in transmit mode, the same indicator can be read against the bottom line indicating the power being transmitted.

R±XXX – displayed under Rx DbM level in the waterfall is the current RIT value.

[SWR]
1 2 3 0.9: During transmission the SWR meter displays the standing-wave ratio value of your antenna system.



: This chart Indicates the settings of the DSP receiver filter



Operation

In order to familiarize yourself with the functions and capabilities of the G90/S portable transceiver, please read the operation guide fully to understand the powerful functions of the G90/S.

Transceiver start and shutdown

1. **To start the transceiver:** press the  button for a short period of time.
2. **To Shut down the transceiver:** press and hold the  button for 1s.

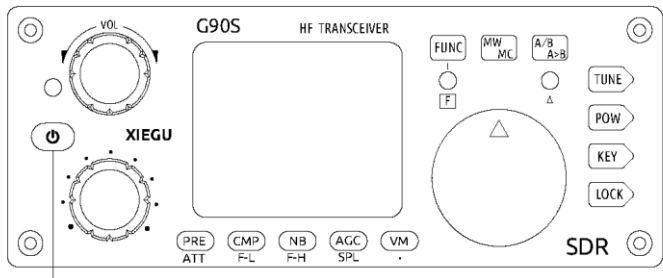

ON/OFF button

To turn off the LCD screen to save power:

While turned on, press the  button quickly to turn off the LED display.

- With the screen turned off, the radio still works normally. Pressing any button or turning a knob will turn on the screen again.

Display of Power Voltage:

After turning on the radio, the upper right corner of the screen will display the DC voltage of the connected power supply.

The supply voltage is 13.8V.



◆ Operation above the maximum voltage given in the specifications will seriously damage the radio!

◆ The displayed voltage may vary $\pm 0.3V$ from the actual value.

The G90/S is uniquely designed such that lower in-range voltages do not result in significantly reduced TX power or RX performance.



Selection of Working Frequency Range

The G90/S receives 0.5~30MHz but is set to only transmit on the amateur radio bands. The amateur bands are divided into 10 frequency blocks.

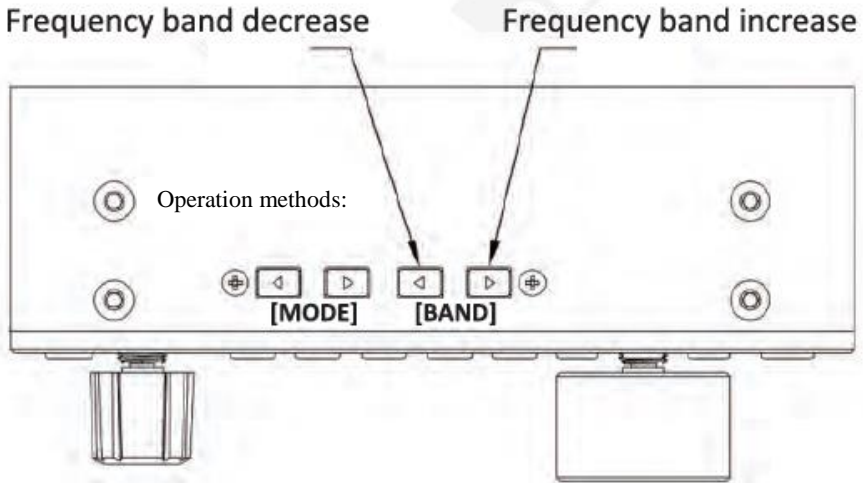

Pressing the [$<$] or [$>$] BAND buttons will cycle through these bands.

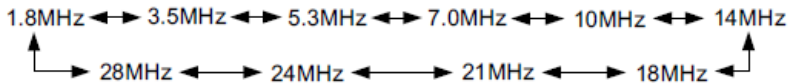

- As well as the amateur bands shown, SW broadcast bands can be added in the sequence through system menu option 8 “Band Stacking”. This allows quicker selection of the broadcast bands to listen to them. Transmission mode is only available on the Amateur bands.
- The 60m frequency range set is 5.330.5-5.405MHz and includes the ITU WRC15 band of 5351.5 kHz to 5366.5 kHz plus the US channel frequencies. Should you require other channels or bandlets for example for operation in the UK, please contact your dealer so that he can program these in the unit for you.
- Frequency ranges for the bands can be dealer pre-set prior to sale in accordance to the regulations of the country (or region) of sale.
- VFO-A and VFO-B are two independent VFOs that can be set to different operating bands. See [VFO Settings] for details.



Operating Mode Selection

Press the [MODE] button to switch through all transmission modes:

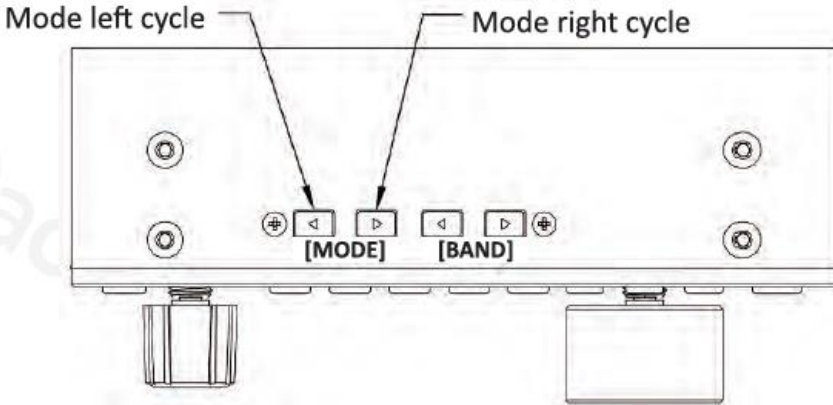

LSB – L-D – USB – U-D – CW – CWR – NFM – AM

The two data modes LSB-Data (L-D) and USB-Data (U-D) were added in FW 1.79b02.

Volume adjustment

Speaker mode:

Turn the volume knob to the left or right to adjust the output volume.

Headphone mode:

1. A short press of the volume knob switches to or from the headphone output mode.

2. Turn the volume knob to the left or right to adjust the headphone volume.

◆ Please turn the volume to the minimum setting before using earphones so as to protect your ears. Gradually increase the volume to be appropriate as required after the earphones are inserted.

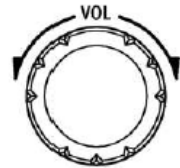

Volume knob



Call Sign Editor

This G90/S can set your call sign to be displayed on the startup screen.

1. Apply a long press to the [VM] button to enter the text editor.
2. The bottom of the screen is the character selection area. Rotate the main tuning knob to select the desired character. Press the main tuning knob in to select the character;
3. Press the [NB] button (underneath BACK on the screen) to delete the last character; press the [VM] button (underneath QUIT on the screen) to exit the editor interface; press the [PRE] button (underneath SAVE on the screen) to save and exit the editor interface.

These LCD screen labels will be close to, but not exactly aligned with the buttons below the screen.

4. When the radio is re-started, your callsign will be displayed on the screen.

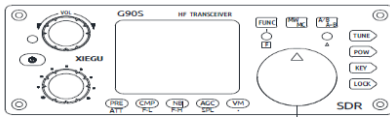

Main knob

Setting Operational Frequency.

There are three methods to set the frequency of G90/S. You may use the large main knob, the multi-function knob or the keypad buttons on the hand microphone.

1. Set frequency by using main knob

Momentarily press the main knob to select 100Hz, 1kHz, 10kHz or 100kHz steps. The selected range step position in the display will be graphic reversed.

Rotate the main knob to set the frequency required using the currently selected step.

2. Set frequency by using the multi-function hand microphone

Press the white [F-INP ENT] button on the hand microphone. The G90/S will now be in frequency setting mode. The cursor will be blinking in the first column on the left of frequency display.



Input the desired frequency values number by number and then press [F-INP ENT] again to complete setting the frequency.

For example, press the keys in the following sequence to set current frequency to 14.09000MHz:

1. Press [F-INP ENT] key first;
2. Press the number keys 1 by 1;
3. Press [F-INP ENT] button again to complete the action.

3. Quick adjustment of the frequency with the multi-function knob

The Multi-function Adjustment Knob of the G90/S provides a method to quickly tune across the band. The function knob's default function and increment is 100khz. Hop from the CW to the SSB areas of the band in seconds.

Note: This only works if the multi-function knob is set to change frequency. If its function has been changed (e.g. to SQL level) you will not be able to tune using the multi-function knob.

Adjustment of RF Gain and Muting Level

Proper RF gain adjustment can improve the quality of a received signal. In general, reducing the RF gain level on the low bands (40/60/80/160m) which have strong interference can significantly improve receive quality. *In general, with SDR rigs, operating at full RF gain is detrimental to receive signal quality. Experiment with levels to find what is best for you.*

How to adjust the RF gain:

1. Apply a long press on the [AGC] button at the bottom of the screen to enable the setting of RFGAIN.
2. Rotate the main tuning knob to adjust the RF gain value.
3. After setting your RF gain level, press the main knob inwards momentarily to exit the RF gain setting mode

SQL setting

You set the squelch level when you want to mute static in between transmissions normally used on AM or FM modes but will work on all phone modes.



Squelch Operation (prior to firmware v 1.75):

1. Apply a long press on the [Multi-function Adjustment Knob] to enter the user defined function menu. Rotate the **main knob** to select the SQL Level option.
2. Rotate the [Multi-function Adjustment Knob] to set the squelch muting level. At the same time, the muting level will show on the main display.
3. Momentarily press the button below the SAVE label at the bottom of the screen to select and exit.

■ The muting strength gradually increases from S1 ~S9, corresponding to signal strength. For example, when the muting level is set to be S3. it indicates that the speaker will only let sound through when the signal strength is more than S3. Otherwise, the speaker will remain silent.

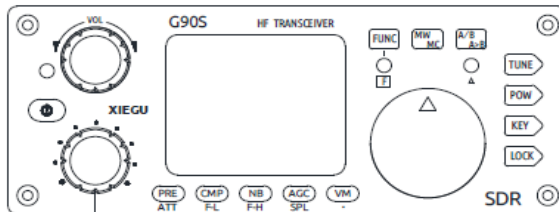

Multi-function
adjustment knob

Multi-function Adjustment Knob (from FW version 1.75 onwards).

The multi-function knob has several functions than can be customized.

- By default, turning the knob will tune the radio in 100kHz frequency steps. (this is the most common use)
- However, a momentary press of the knob allows adjustment of the receiving filter.
- Giving the Multi-Function knob a longer press, enters the user defined functions menu.



Once in the user defined functions menu turn either the multi-function knob or the main tuning dial to go to one of the following functions:

1	Freq 100k	Frequency stepping value
2	SQL level	Muting level setting
3	PO Level	Transmitter output power
4	Key Speed	Automatic keyer rate
5	FFT Scale	Spectrum reference level

When you are on the function you want to adjust e.g. squelch, momentarily press the multi-function knob in again. This will take you back to the normal operating screen. As soon as the receive screen is displayed rotate the multi-function knob and where the bandwidth icon is normally displayed on the screen, the available values for the selected function available will be displayed as you turn the knob. When you have the value displayed that you wish to have, momentarily press the multi-function knob again to keep the value.

Note: If you wait too long you will be put into DSP filter adjustment mode. If this happens, start again.

Reception and Transmission Operations using SPL and VFO/A/B

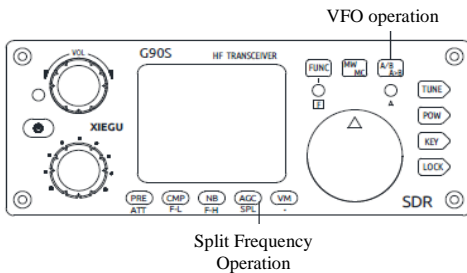

The G90/S transceiver has two built-in, independent, VFOs which can be set to different frequencies and different modes. Using the SPL (split) function, you can transmit and receive on different frequencies or even bands.



VFO setting:

1. Momentarily press the [A/B / A>B] button to switch between VFO-A and VFO-B;
2. Set the required VFO frequency and mode when on one VFO (A or B).

Split Operation (SPL);

1. Set the required receive frequency and mode on VFO-A first;
2. Then set the transmitting frequency and mode on VFO-B;
3. Press the function button, then the [AGC/SPL] button to turn on the SPL (split) function. The double-triangular icon will display between VFO-A and VFO-B on the VFO area of the screen.

◆ As well as using them for split mode VFOA/B can simply be used to set two different simplex frequencies and modes so you can quickly switch between the two in real time.

Automatic Gain Control (AGC)

Select the appropriate AGC time constant for the best receiving experience:

1. Momentarily press the AGC button at the bottom of the screen to cycle through the three AGC selections:

AGC-S → AGC-F → AGC-A → AGC --

AGC-S:	Slow AGC control	Recommended settings:	AM mode: AGC-S
AGC-F:	Fast AGC control		CW AGC-F
			SSB: AGC-S
AGC-A:	Automatic AGC control		
AGC	AGC OFF		
	<i>See below:</i>		

2. When the AGC-A mode is selected, the radio will automatically select the appropriate AGC control parameter depending upon the current mode.

■ *As of firmware version 1.73 with the AGC disabled, the receiver will have its RF gain automatically set to 25% so that noise received is not significantly increased.*

NOTE:

You should experiment with the AGC Off mode only if the received signal is not



changing in strength due to fading (QSB). You must manually control the RF gain level so that you do not have distortion from the incoming signal overloading the receiver. Set AGC to “off”, then go into the RF gain setting (Hold the AGC button in for 2 seconds) then adjust the main knob until the signal sounds clear. This can result in a nice improvement of signal quality under good receiving conditions, especially for weak signals!

PRE-AMP/ATT (combined control)

The pre-amplifier can improve reception of some weak signals in the higher frequency bands. These are normally the bands above 20 meters. When adjacent signals are de-sensing the listened to station applying the attenuator can help. This is normally on bands below 40m.

1. Press the [PRE] button at the bottom of the screen in momentarily and the character P will appear on the top left corner of the screen indicating that the pre-amplifier is turned on.
 2. Press the [PRE] button again and the character A will appear on the top left corner of the screen, indicating that the attenuator is turned on.
 3. Press the [PRE] button again and no character will appear on the top left corner of the screen, indicating that neither preamp nor attenuator are engaged.
- The receiver is sensitive enough that under 18mhz, no improvement of the signal to noise ratio will occur with use of the pre-amp. To maintain the best reception performance, limit use of the pre-amp to bands above 20 meters.
 - When the S meter displays that the received signal exceeds S9+20dB, turning on the attenuator is recommended to provide better reception.

Pulse Interface Suppressor – Noise Blanker

Pulse interference suppression can effectively eliminate some kinds of pulse noise, especially interference caused by automobile ignition systems.

1. Press the [NB] button at the bottom of the screen momentarily to enter the NB function setting - and a corresponding menu will display on the screen where the DSP filter graphic normally is.
2. Repeated momentary presses of the [NB] button will select the different NB function setting options. Rotate the main tuning knob to set these values.

The NB function menu includes the following options:

- NBSW: NB operation switch ON/OFF. Default is OFF



- NB Level: setting of NB suppression level.
- NB Width: setting of NB suppression width
- Adjust the Level and Width while listening to the noise you want to suppress for best effect.
- Improper settings of the NB parameters will severely degrade reception.

Do not turn the NB on unless you need to suppress pulse noise.

Voice Compression CMP

Voice compression can increase the average TX power output during phone communication so that communications are possible under poor conditions.

1. Press the [CMP] button at the bottom of the screen in momentarily and the voice compression indicator (a microphone) will appear at the top of the screen.
2. Press the [CMP] button again to disable voice compression.

Use voice compression only when you need it, as all compression degrades transmitted audio quality slightly. When conditions are good, leave it off.

CW (Morse Code) Communication

You may use a CW key or an external keying unit. Insert the connector into the KEY port on the rear of the radio. (See Page 10 for the definition of the required plug wiring)

1. Insert CW Key/Keyer into the KEY socket on the rear of the main unit;
2. Press the [MODE] button to switch to CW (or CWR) mode;
3. Enable the QSK function by pressing the [KEY] button until the function appears, also set the appropriate QSK time;
4. The radio will key into transmit when the Morse code key is pressed.

Practice mode

You can use the G90/S as a CW code trainer using the following method:

- Disable the QSK function for the [KEY] function. Only the CW sidetone of the transceiver will be heard when using the CW key. Signals will not be transmitted.



CW automatic decoding

A long press of the [KEY] button enables CW automatic decoding. Rotate the main tuning knob to fine tune the received signal until the indicator light A flashes in time with the code. Decoded CW text will appear at the bottom of the screen.

■ Since the accuracy of the automatic decoding of Morse code is related to the received station's CW accuracy, received signal quality, and frequency accuracy of the other radio, Auto CW decoding is only an addition to using your own ears for decoding. It can also be useful when learning Morse code.

When using automatic CW decoding, for best results, the bandwidth of the receiving filter should be set to 300Hz. Also, adjust the keyer speed on the G90/S to approximately the speed of the incoming CW for the best decoding results. The G90/S's CW decoder is capable of excellent performance when adjusted correctly.

CW Keyer settings

The [KEY] button function has settings required for normal CW communications. Press the key in momentarily to select, in turn:

- SPEED: automatic key rate setting
- M/L/R: settings of manual/ automatic left- and right-hand modes
- MODE: Iambic A/B mode setting
- QSK switch: turn QSK on or off
- QSK Time: QSK time setting
- Ratio: set the automatic key dot-and-dash interval ratio

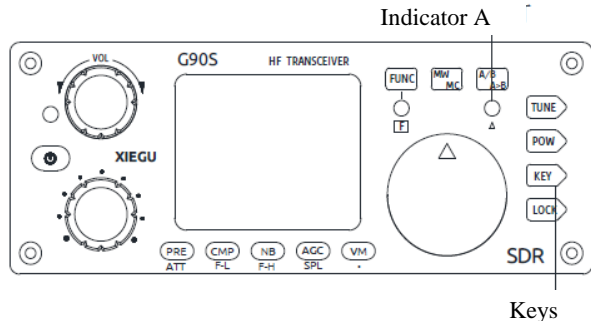



To enter the second function of the [KEY] button press [FUNC] button and then [KEY] to select and set the following options. Once adjusted using the main tuning knob, press the KEY button again to exits the settings process.

Options:

- CW Volume: sidetone volume setting
- T800Hz: sidetone tone frequency setting
- B500: CW receiving bandwidth setting (the default value is 500Hz) – set to 300 if using the automatic CW decoder function.

SSB Voice Communication

Plug the lead from the hand microphone into the MIC port on the right-hand side of the head unit. After inserting, the green indicator light on the hand microphone will light.

1. Press the [MODE] button (< or >) on the top of the head unit to switch between LSB and USB mode. Ensure you do not select U-D or L-D.

2. Use the second function (after [FUNC] button has been pressed) of the [POW] button for the following settings:

1) MIC GAIN: set the level of the hand microphone audio

2) INPUT: select where the audio input comes from (the default is MIC and this is required during voice communications).

3. A momentary press of the [POW] button allows you to set the output power level.:

1) POWER: Set the required PEP output level (range is 1W - 20 W).

2) SWR THR: set the standing-wave-ratio protection threshold (default is 3:1). If the radio sees an SWR over this value it will reduce power to protect itself.

4. After you have set the parameters above you are ready for SSB communications.

■ The default hand microphone voice gain value is appropriate in most cases. Watch the spectral display when transmitting and if you see extra lines above and below the main audio trace, reduce the mic gain or move away from the microphone until they disappear. Normally a setting of 10 is a good place to start. You should see the TX power readings peak at the level you set. The average meter indication will be lower. This is normal.



Voice-controlled Transmit - VOX

The voice-controlled transmission (VOX) feature can automatically judge whether there is a hand microphone connected or if audio is coming from the line input signal (on the ACC socket). It will automatically control the radio switching between the receive and transmit when audio is detected. When the VOX function is activated, it is unnecessary to press the hand microphone PTT key to start the transmission.

After pressing the [FUNC] button to activate the secondary functions of all buttons, press the volume knob IN and you will enter the VOX function settings. Rotate the main tuning knob to change values. Press the VOL knob in again to go through the different settings.

- VOX OFF/ ON: VOX function off / on
- VOX GAIN: voice control gain setting (recommended setting is 50)
- ANTI-VOX: echo suppression settings for the hand microphone in conjunction with the receiver speaker (recommended setting is 50)
- VOX DLY: VOX hang time (default is 0)

■ The VOX voice-controlled TX function can be used with both the hand microphone and the line input. You can simply connect audio from your PC's audio output and input lines to the rear ACC connector (or via the CE-19 accessory) and the VOX function will handle switching the radio between TX and RX automatically without needing to have a transmit "PTT" control line.

Setting Line level Input into ACC connector:

When the AF-IN pin of the ACC interface is used for line input audio, (when using the U-D or L-D mode) you need to set the appropriate input volume in the "AUX IN Volume" option in the system menu. Set it at a mid-level value first. Then watch the TX power output and adjust your incoming audio from the PC. (using the PC's sound card output volume level control). Remember that for digital data modes (e.g. FT8) you want to set the radio at about 50% of full output so as not to overheat the radio or distort the signal. With a good antenna, 10W average output is sufficient for most digital mode communications. Keep a check on the temperature of the radio when you operate digital modes (and in general). Your ambient temperature might be 55F (12C) or 105F(40C) and this has a major effect on heat build-up. If the radio becomes very hot, you'll need to reduce power and give it time to cool-down. The radio's transmit section is very conservatively designed, but any radio can suffer from over-temperature under certain challenging operating conditions, such as the long 100% duty cycle periods of some digital modes.



Automatic Antenna Tuner

The G90/S has an efficient ATU to help you quickly match many kinds of antennas effectively.

1. Press the [TUNE] button momentarily to bring the built-in antenna tuner into circuit. An antenna icon will appear at the top of screen.
2. To initiate an antenna “tune”, hold the [TUNE] button for > 2 sec.

Note:

1. Pressing the (TUNE) button momentarily will show the antenna icon on the screen. This indicates that antenna tuner is in-line. If you need to tell the ATU to tune (new antenna, different frequency) hold the Tune button in for >2 sec.” Tuning” will be displayed.
2. After the antenna is “tuned” (actually it is matched to the radio rather than “tuned”), leave the ATU ON so that it will provide the antenna match during operation.
3. If the "SWR" icon is displayed at the top of the screen and flashes once while transmitting – even after tuning, this indicates that the standing-wave of current antenna is too high and while another tuning action may be attempted, this could also indicate a faulty antenna.
4. When performing a tuning action via a long press of the Tune button, the tuner will go through its complete matching procedure and then return to receive mode after completion. (this may take several seconds)
5. When your antenna is physically very close (e.g. a vertical mobile antenna), strong radio frequency interference may be caused to the radio or electronic equipment nearby. If this happens try to locate the antenna further away.

Standing-wave Scanner SWR

The G90/S has an **antenna SWR scanning function**. It can scan the standing-wave values of the connected antenna to help you adjust the antenna.

1. A long press of the [POW] button enables the standing-wave scanning function. It will scan the SWR of the antenna currently connected.
2. Press the button below the BW label on the screen momentarily to switch the frequency step of the scan.
3. At the bottom of the screen, the frequency of the lowest SWR point of the scanned standing wave is indicated. This is where the antenna is “resonant”.



- Press the button below the FAST/ SLOW label on the screen momentarily to select the scanning speed.
- Press the button below the QUIT label on the screen to exit the standing-wave scanner.

Corresponding location of keys VS. screen labels:

(They are not *perfectly* aligned vertically)

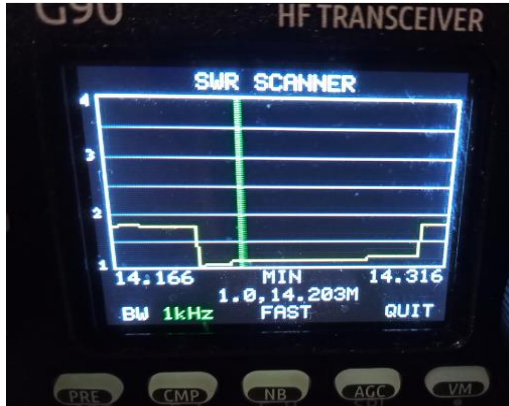

BW: Corresponds to the [PRE] key

FAST: Corresponds to the [NB] key

QUIT: Corresponds to the [VM] key

◆ The SWR scanner is for quick reference only and is not meant to replace a dedicated antenna analyzer. It is a very useful tool for trimming and adjusting an antenna when operating portable or for spotting a faulty antenna. The text underneath the graph (1.0 , 14.203M) indicates that the best SWR found is 1.0:1 at 14.203MHz.

Fine Tuning of Received Frequency (RIT)

Sometimes a station will come back off-frequency. Rather than tuning your frequency to the other station's it's better to add some "Receiver Incremental Tuning" to correct the other station's frequency.



- A long press of the main tuning knob enters the RIT adjustment interface.
- Rotate the main knob left or right to adjust the RIT value. The adjustment range is ± 500 Hz.

◆ *When RIT is no longer required, reset the RIT value to 0.*



Line Input and Output

The G90/S has an external line input interface. When the G90/S is used for data communication in conjunction with a computer or an external modem, the correct signal input options need to be selected.

1. Feed the external audio signal into the corresponding pin of the ACC port (see the interface description on page 10).
2. Selecting the U-D or L-D mode, will automatically set the audio input to the radio to come from LINE input pin on the ACC socket and disable MIC input. In U-D or L-D mode, audio output becomes available on the ACC socket (as well as the speaker/headphones).
3. In the system menu, select: AUX IN VOLUM to set the appropriate input volume level. (see below)

Operation of line output:

In the system menu, select: AUX OUT VOLUM and set it to the appropriate output level. Your computer software package will have a meter showing best input levels.

■ When using digital communications via the ACC port, the TX audio drive level should be capable of 200mv.

■ The audio output level from the computer to the radio should be adjusted so that the ALC value displayed on the screen is between 30 and 85. The lower the ALC value, the better. You should set the radio at your required output level and then adjust the PC's sound card output so that the radio's ALC is within range. Excessively high input signal level will overload the input amplifier, resulting in modulation signal distortion. With the ALC set correctly, the TX output reading may jump around rapidly under digital modes - but average power levels will be in the correct range for a clean and effective signal. Digital modes require much less TX power than other modes to make a contact.

In the system menu, the following two settings are the ones to adjust for data communications:

5	AUXIN Volum	Line input volume setting
6	AUXOUT Volum	Line output volume setting

◆ For digital data communications, the PC output level is adjusted together with the "Line input volume" (your TX audio) in the radio. The level of the audio input to the computer is adjusted in conjunction with the radio's "Line output volume" (received audio going to the PC). The PC settings are normally found under "Sound devices". It is best to set the radio to a mid-level value and then adjust the PC's levels to achieve correct operation. Fine tuning from that point can be done through the G90/S's menu settings.



Channel Memory Write (MW) and Clear (MC)

Basic operations:

1. While in VFO mode, set the required frequency, mode, and any other parameters you desire.
2. Press the [MW/MC] button momentarily and the CH 00 (channel number) character will appear on the screen flashing. Rotate the main tuning knob to select an empty channel. At this time, the character E will appear after the channel number, indicating that the channel is empty and can be used for storage.
3. Press the [MW/MC] button again momentarily to save the current frequency and mode information to the selected channel.

Selecting the stored memory channels:

1. In VFO mode, press the [VM] button momentarily to enter channel mode.
2. Rotate the main tuning knob to switch to the required channel.

Clear channel memory:

1. In channel mode, press the [FUNC] button followed by the [MW/MC] button. The channel number indicator will start to flash in red.
2. Rotate the main tuning knob to the channel to be wiped. Press the [MW/MC] button again to clear the selected channel.

Transmitter Power Setting

1. Press the [POW] button momentarily to enter the power setting mode. The display area on the right side of the screen will display the current “Po” power output setting value in watts.
2. Rotate the main tuning knob to set the power to the desired value in steps from 1W to 20W.

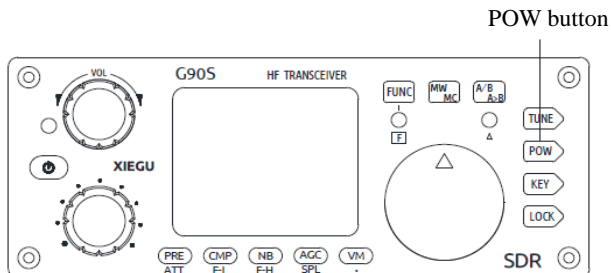



◆ It is always good to start with reduced TX power if you are unsure of your antenna's condition or are new to the operation of your G90/S. Once you know your SWR is low and grounding is good, the radio is designed to operate at full power comfortably.

Digital (DSP) Filters (from FW version 1.79b02 onwards)

The G90/S has a built-in variable digital filter that can continuously adjust the bandwidth of the receiver's input to improve reception of the desired signal

With FW v 1.79b02 the G90 changed to an updated 2 BPF mode – The band-pass filter is changed to allow 2 BPF defaults that can be switched between. The default values of each filter by mode are:

Mode	BPF1	BPF2	Bandwidth (kHz)
SSB	300 ~ 3000	300 ~ 3000	2700
SSB DIG	100 ~ 3100	100 ~ 3100	3000
CW	-250 ~ 250	-250 ~ 250	500
AM	-3000 ~ 3000	-3000 ~ 3000	6000
NFM	-4500 ~ 4500	-4500 ~ 4500	9000

Note: Negative numbers for frequency indicate that the frequency being used is to the left of the center of the spectrum (i.e. the lower sideband).

Adjustment of the bandpass filters is now performed as follows:

Put the radio in the required mode:

- ▷ Short press the MFK button to switch between BPF1/BPF2 (colour changes slightly)
- ▷ Turn the MFK encoder to adjust the selected BPF
- ▷ Long press the MFK key or the FUNC key or any other menu key (POW, KEY, etc.) to exit the selection.

Selecting the default filter to be used - press the FUNC button (light comes on):

- ▷ Press CMP/F-L key to set BPF1 to be the default
- ▷ Press NB/F-H key to set BPF2 to be the default

Tip:

- ▷ B2700 above the filter icon means that the bandwidth is set to 2700Hz

*Receive bandwidth can also be set using CI/V CAT commands
FE FE 70 E0 1A 05 00 10 followed by 2 numbers and then FD. 01 to 20 will set the HPF to 100-2000Hz 05 to 24 to set LPF 500-2400Hz (the first number must be less than second).*



Receive filter operation prior to firmware v 1.79b02:

The G90/S has two filter adjustment modes: center frequency point mode and bandwidth mode.

1. Press the [Multi-function] knob momentarily to switch between the two filter modes.
2. When the center frequency point mode is selected: The prompt text "Cxxx" appears over the filter icon ("xxx" refers to the center frequency point value) and a green vertical line displays on the orange trapezoidal shape.
3. When the bandwidth mode is selected: The prompt text "Bxxx" appears over the filter icon ("xxx" refers to the bandwidth value) and a green vertical line displays on the both sides of orange trapezoid.
4. When either the center frequency point mode or the bandwidth mode is selected, rotating the [Multi-function] knob adjusts the values.

Note: Press the multi-function button in once before adjusting by turning the multi-function knob and press the multi-function knob in again once the change is complete, to store the setting. (the vertical green bars go off once the setting is stored).

How to adjust the low and high cut-off frequencies of the filter:

1. Press the [FUNC] button momentarily to enable the operation of alternate button functions.
2. Either press the [CMP/F-L] or [NB/F-H] button and rotate the main tuning knob to adjust the lower or upper cut-off frequencies of the filter. Press the [CMP/F-L] or [NB/F-H] button again momentarily to display the currently set bandwidth values in the function display area of the screen. 200/2750 is a good starting point for SSB operation.

- F-L: Adjust the low-end cutoff frequency of the filter
- F-H: Adjust the high-end cutoff frequency of the filter

Method to reset to the default filter parameters:

1. Press the [FUNC] button momentarily to enable the operation of the alternate button functions.
2. Long press the [CMP/F-L] or [NB/F-H] button to reset the upper or lower cutoff frequencies of the filter to their default values.

In the Center frequency mode (see above) you can move the center of the



bandpass filter around the current frequency to reduce interference from adjacent signals either above or below your operating frequency.

- ◆ Properly adjusting the filter parameters can greatly improve the performance of the receiver as well as its sensitivity and signal to noise ratio.
- ◆ In CW mode, the digital filter can be made as narrow as 50Hz but there will be obvious deterioration of the resulting audio at such an extremely narrow setting. 300-500 Hz is normally ideal.

Spectrum/ Waterfall Display

The G90/S radio can display the radio spectrum and waterfall diagrams of received signals and you can quickly observe whether there is a signal on the desired frequency of operation. You can also easily identify a clear frequency to QSY (move freq.) to in case there is QRM (interference) occurring on the frequency you are currently using.

Spectrum display bandwidth is 48kHz

The spectrum signal strength value displays with an accuracy of $\pm 2\text{dB}$

The sensitivity of the spectrum display (scale) can be adjusted for the conditions of the band you are operating on. If the scale is set too high, very strong signals may have their signal peaks cut off. You may adjust the scale by doing the following:

1. Press the [FUNC] button momentarily and then the lock button, to enter the SCALE reference level setting.
 2. Rotate the main tuning knob to adjust the SCALE value until the display sensitivity is appropriate.
 3. Press the main tuning knob in momentarily to save and exit the setting screen.
- The SCALE reference values gradually increase from 1 to 10. When strong signals are observed, scale values need to be lowered. When looking at weak signals, the SCALE values can be increased. Generally, bands under 14 MHz will need less sensitive settings.

■ The SCALE value in each frequency range can be set independently. The second function (with the FUNC button activated) of the [LOCK] button is as follows:

- SCALE: set the reference level setting
- AVE: set the average value setting



AVE “average” values gradually increase from 1 to 10. The effect on the display is to smooth out rapid changes and provide a better representation of band activity. This setting is a matter of personal taste. It can improve usability of the spectrum display.

Data Communication

The G90/S supports all PC-generated amateur data communication modes and remote control via computer software when a PC is linked to the radio. Only simple wiring is needed to enable amateur data communications. The optional DE-19 digital interface allows one USB cable connection to your PC to handle both audio (data) traffic and serial control and is simpler than the process defined below.

Version 1.79b02 firmware added the L-D and U-D (LSB-DATA and USB-DATA) modes which switch the bandpass filter and ensures audio input and output via the ACC socket only, disabling microphone audio.

The appropriate transmission mode should be selected for the data mode in operation. The recommended modes for common data modes are as follows:

Data mode	Radio mode
PSK31	USB/USB-D
RTTY	LSB/LSB-D
FT4/8	USB/USB-D

* For other data modes, set the radio mode to what is commonly used for that data mode.

When an amateur radio and a computer communicate using digital data communication, the computer is used as a "modem" in that it converts the signals to and from digital tones. While receiving, the audio from the signal received is sent to the computer for demodulation. When transmitting, the audio signal created by the computer is sent to the radio for transmission. Thus, the computer's audio output level effects the TX power output and ALC readings. The connections required are as follows:

Receiving: Received audio from the receiver → computer audio IN

Transmitting: The computer-generated audio signal → radio TX Audio IN

Preparation:

For CAT command control of the radio from the PC you may use the supplied USB->3.5mm plug cable or the optional DE-19 interface unit. Before using the cable/unit for the first time, download and install the appropriate driver from the Radioddity website. When you then plug the cable into your Windows PC it will use this driver and not go off to search for an (incompatible) one from the Web.



NOTE: currently a **BLUE-USB** plug equipped cable being supplied with the G90/S which uses FTDI chips in it to convert from serial-TTL to USB. Earlier a **BLACK-USB plug** cable using Prolific chips was supplied. You need to download the drivers related to the chipset in your cable from the Radioddity website. (Note if you use Linux or MAC rather than Windows, additional drivers for these operating systems are available at the FTDI website).

- Although it is possible to connect using individual audio cables, the DE-19 Interface unit (optional purchase) provides more convenient connections.
- Adding a few snap-on ferrite RF chokes will protect against RF getting into the audio path.

Cable connection steps

1. AFTER INSTALLING THE DRIVERS ON THE PC. Insert the USB plug of the serial data cable or the DE-19 unit into the computer. Insert the 3.5mm plug of the cable or from the DE-19 into the communication port on the left side of the G90/S head unit **only after the radio has been turned on.** (If using a DE-19 unit instead of the USB-serial cable, this can be connected before power on).
2. Insert the 8-pin ACC cable provided with the DE-19 into the ACC port at the rear of the G90/S base unit and the other end into the corresponding port on the DE-19 (You can also use a CE-19 interface or make up your own direct audio lead ideally with some audio isolation).
3. In the case of using the DE-19 unit, one end of the supplied USB cable plugs into the USB-C socket on the DE-19. The other end plugs into any of your PC's USB-A sockets.

NOTE: If you are not using a DE-19 or CE-19 unit you will need to provide a two-way audio path between your PC and the ACC socket on the G90. Older PCs may have separate 3.5mm audio out and audio in ports, more modern ones come with a single (4-connector) socket wired to take a smartphone type headset.

4. Either select a data mode e.g. U-D (only after FW 1.79b02 or later has been installed). If using an older firmware level, you will have to set the G90/S to "Line input" mode (i.e. take the audio from the ACC socket rather than from the hand microphone.) and set the G90/S to the appropriate TX mode for the particular digital mode you are going to use. For most digital modes, that is USB.

■ Remember to keep the PC audio (speaker) level output low and watch your ALC level when going onto transmit. Raise the PC output level until you see the ALC just start to respond...and then stop. TX power output will be lower than



the power set as the radio's power output setting. This is so the signal is perfectly clean for digital operation and to avoid the radio overheating. This is normal procedure for digital modes.

- You can add clamp-on ferrite RF chokes to the USB data cable and the ACC cable if you experience any stray RF getting from the radio into the PC. For better performance, loop the wire through and then around and through the clip-on ferrite choke again - then clamp it shut. Additional wire passes through the ferrite choke improve filtering.

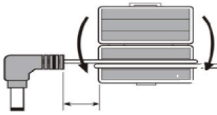

The USB-Serial port should be configured on your PC as 19200 bps, 8data bits, no parity, 1 stop bit.

Digital Mode Connections

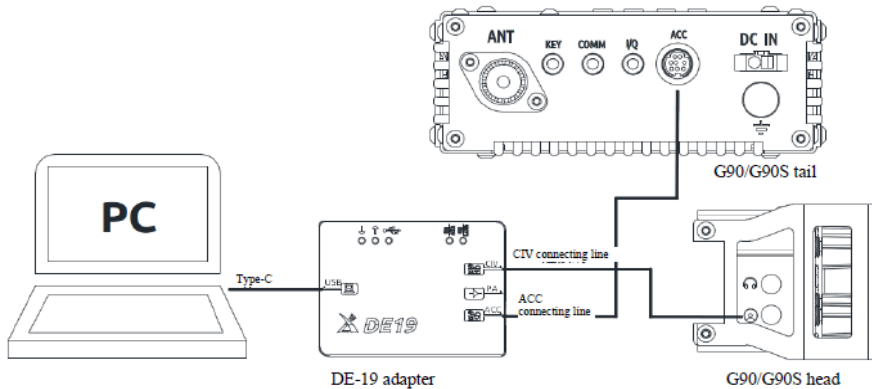

When using the DE-19 one cable goes from the DE-19 to the PC's USB port, one to the ACC port and one lead to the COMM port on the head unit.

The wiring of the 3.5mm sockets are shown on the CE-19 board.
 The port labelled X5105 is also for the G90/S and accepts the 8-core cable from the ACC port of the radio.

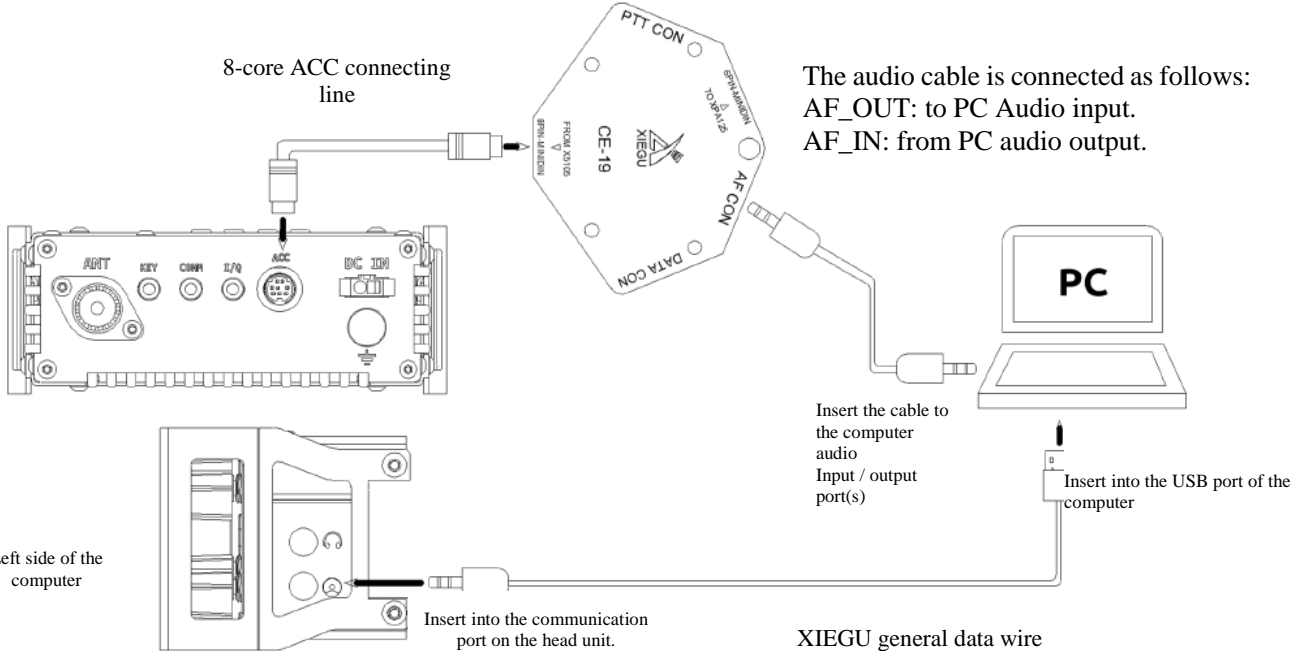

Schematic Diagram of Wiring for G90/S Data Communication using the older CE-19 box



Connecting the XPA125B amplifier to the G90/S (optional)

The G90/S connects to the XPA125B power amplifier using the CE-19 or the newer DE-19 adapter. The XPA-125B's antenna tuner is rated for full power output from the amplifier (at least 100w).

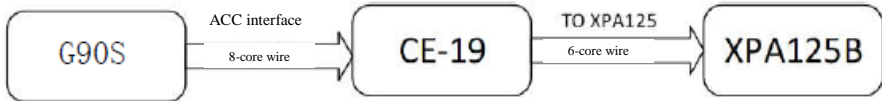

Diagram of Wiring between G90 and XPA125B using a CE-19 or DE-19 unit

Once connected, the G90/S can automatically control the band switching of the XPA125B. The transmit ALC connection is also handled via the CE-19 or DE-19 adapter. If the G90/S output power exceeds the maximum input power to the XPA125B, the ALC control automatically decreases the G90/S's output power to avoid over-driving the amplifier.

The output power of the G90/S should be set to be $\leq 2.5W$ to protect the amplifier. The amplifier can give full output power with very little drive on the input socket.

- The 8-pin ACC wire is included with the CE-19 or DE-19 kit. The 6-pin ACC wire is included with the XPA125B to work with the CE-19 (an L-4001 cable is required for use the XPA125B with the DE-19). A coax patch lead is required to go from the G90/Ss output port to the amplifiers input port (user supplied)

Factory Reset

Factory Reset

If the radio's operation becomes abnormal in some way, you can restore the radio to the original factory settings.

Operational steps:

1. With the radio off, hold the FUNC button in and press the power button quickly on the radio to start the restoration of factory settings.
2. Press the [PRE] button to confirm the reset. Press the [VM] button to cancel the operation.

- Default parameters can meet most operating needs. This is a good test to see if your radio is operating normally.



System Menu

The system menu enables a good amount of customization. Many of these are a matter of personal preference.

Operation method: Hold the [FUNC] button 1-2 sec. to enter the system menu.

The definitions of menu functions are as follows:

S/N	Menu item	Function description
1	Handle up/down	Hand microphone up/down key function setting
2	Handle F1	Hand microphone F1 key function setting
3	Handle F2	Hand microphone F2 key function setting
4	LCDBL	Screen backlight brightness setting
5	AUX IN Volum	ACC port input audio volume setting
6	AUX OUT Volum	ACC port output audio volume setting
7	RCLK Tune	Reference clock adjustment
8	Band Stack Mode	Band stack setup
9	ON/OFF Beep	ON/OFF of system beep
10	Version	Firmware version No.

Description of the labels displayed at the bottom of the screen:

PREV: previous page.

SAVE: after adjusting the system menu settings, press this key to save and exit.

EXIT: exit the system menu interface directly without saving changes.

NEXT: next parameter to be adjusted.

Use the main VFO tuning dial to change values.

Menu item 1: Handle up/down

Function: Customize the function of [▲ ▼] buttons on the hand microphone.

Optional value: FREQCH+/- Frequency/channel+/-
 BAND+/- Band+/-
 VOLUM+/- Volume+/-

Default: FREQCH+/-

Menu item 2: Handle F1



Function: Customize the function of [F1] button on the hand microphone.

Possible options: PRE/ATT
SPLT
NB
COMP
AGC

Default: PRE/ATT

Menu item 3: Handle F2

Function: Customize the function of [F2] button on the hand microphone.

Possible options: PRE/ATT
SPLT
NB
COMP
AGC

Default: SPLT

Menu item 4: LCD BL

Function: Set the brightness of the backlit display

Adjustable range: 10%~100% The larger the percentage, the higher the brightness
Default: 80%

Menu item 5: AUX IN Volum

Function: Set the volume of ACC port input audio signal

Adjustable range: 0~15 The larger the value, the greater the volume
Default: 8

Menu item 6: AUX OUT Volum

Function: Set the level (volume) of ACC port output audio signal

Adjustable range: 0~15 The larger the value, the greater the volume
Default: 15

Menu item 7: RCLK Tune

Function: Adjust the reference clock of the internal frequency synthesizer. (To correct the frequency accuracy of the radio).

Adjustable range: -1000Hz~+1000Hz
Default: 0Hz



i.e.: If you are showing a consistent offset of 20Hz when you are talking to stations, you can adjust the reference frequency by 20Hz to re-calibrate. If you are 20Hz low on your frequency display, set the adjustment to be + 20Hz.

Menu item 8: Band Stacking Mode

Function: Set band stacking mode. When switching through bands, using the band buttons on the top of the radio or the arrow keys on the microphone, you can include or exclude the shortwave broadcast bands in the rotation. This ONLY affects quick switching between bands – the SW broadcast bands remain receive-only. You can only transmit on the Ham bands with this radio.

Options: HAM Band Only display amateur bands
 FULL Band Display Amateur and Broadcast bands

Default: HAM Band

Menu item 9: ON/OFF Beep

Function: Enable/disable and the system beep at startup & shutdown.

Options: Enable/Disable

Default: Enabled

Menu item 10: Version

Function: Display the firmware version of the head and body. e.g.

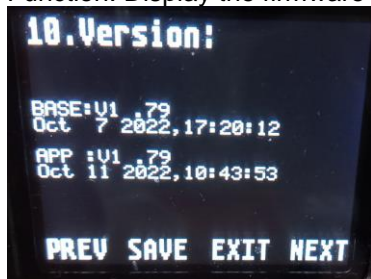

BASE: V1.XX Body firmware version No.
APP: V1.XX Head firmware version No.



CiV Control Instructions

Computer Control Instructions

The G90/S uses a subset of the standard CiV CAT instruction set. You can remotely control the transceiver based on standard instructions or configure control instructions for other software. Serial post speed needs to be 19200bps. Here are the tables of commands that currently work. With later firmware changes, these could be added to or changed.

Commands are prefixed FE FE 70 E0 and suffixed with FD Connection speed 19,200

Table 1 (part 1 of 2) CiV commands			G90 Firmware versions - Head Unit 1.8 base unit
CMD	Sub-CMD	DATA	Description
0x02	-	-	Get Frequency range of receiver. Returned as Freq{dash}Freq in BCD.
0x03 or 0x00	-	see table 2-1	Get active VFO frequency (0x03 preferred).
0x04	-	see table2-2	Get active mode.
0x05	-	see table2-1	Set active VFO frequency.
0x06 or 0x01	-	see table2-2	Set active mode. (06 preferred over 01 as it updates the displayed mode on the radio).
0x07	0x00	-	Select VFO-A
	0x01	-	Select VFO-B
	0xB0	-	Swap selected VFO (A->B or B->A).
0x0F	0x00	-	Turn split operation off. (S symbol stays on in radio display)
	0x01	-	Turn split operation on.
0x11	-	-	Get attenuator state (00 = off, 0C = on).
	0x00	-	Turn attenuator off.
	0x01	-	Turn attenuator on.
	anything else	-	Toggle attenuator state.
0x14	0x01	-	Get receiver audio volume (in BCD format 0-255).
	0x02	-	Get RF Gain
	0x03	-	Get squelch level (returns 1 and 2 char results - not reversed).
	0x09	-	Get CW Sidetone value (in BCD format 0-255).
	0x0A	-	Get Tx power setting (returns 1 and 2 char results - not reversed).
	0x0B	-	Get Mic Gain
	0x0C	-	Get CW keyer speed setting.
	0x0F	-	Get QSK time setting.
	0x12	-	Get NB Level
	0x16	-	Get VOX Gain.
	0x17	-	Get Anti-VOX Gain.
	anything else	-	Always returns 255 or 000 in BCD format.
	0x01	BCD code	Set audio level (range 0-255 in BCD).
	0x02	BCD code	Set RF Gain.
	0x03	BCD code	Set squelch level.
	0x09	BCD code	Set CW Sidetone.
	0x0A	BCD code	Set Tx power setting.
0x0B	BCD code	Set MIC Gain.	
0x0C	BCD code	Set CW keyer speed.	
0x0F	BCD code	Set QSK hang time.	
0x12	BCD code	Set NB Level.	
0x16	BCD code	Set VOX Gain.	
0x17	BCD code	Set Anti-VOX Gain.	
0x15	-	-	All below return a BCD code of 0-255 that equates to 0-100%.
	0x01	-	Get SQL State - (i.e. ON or OFF) not implemented - rather the same SQL-level response as from command 1403 is returned.
	0x02	-	Get S-Meter reading.
	0x11	-	Get output RF power meter reading
	anything else	-	Always returns 255 or 000 in BCD format.



Table 1 (part 2 of 2) CIV commands				
CMD	Sub-CMD	DATA	Description	
0x16	0x02	-	Get Preamp state (On=1 Off=0).	
	0x12	-	Get AGC mode (off=0, fast=1, slow=2, auto=3).	
	0x22	-	Get Noise Blanker switch state (0=off, 1=on).	
	0x50	-	Get key lock status (1=locked, 0=free).	
	0x02	0x00		Turn preamp off.
		0x01 or 0x02		Turn preamp on.
	0x12	0x00		Turn AGC off.
		0x01		Set AGC to fast.
		0x02		Set AGC to slow.
		0x03		Set AGC to auto.
	0x22	0x00		Turn noise blanker off.
		0x01		Turn noise blanker on.
0x50	0x00		Unlock keys and knobs on radio.	
	0x01		Lock key and knobs on radio.	
0x19	-	-	Get radio ID (normally 70 on Xiegu radios)	
0x1C	0x00	-	Get state of PTT switch (1= on transmit, 0= on receive).	
	0x00	0x00	Release the PTT switch (go to receive).	
		0x01	Close the PTT switch (go to transmit).	
	0x01	-		Get state of antenna tuner (returns 00 (off), 01 (on) or 02 (tuning)).
		0x00		Turn internal ATU off. Should only be issued after ATU state is checked as being on, otherwise this will toggle the state.
		0x01		Turn internal ATU on. Should only be issued after ATU state is checked as being off, otherwise this will toggle the state.
		0x02		Perform automatic tune of antenna using internal tuner. If needed turns ATU on before tune action and leaves the internal tuner turned on afterwards.
0x1D	-	-	Get radio ID XIEGU ONLY command (non-standard CIV command)	
0x25	0x00	-	Get currently selected VFOs frequency (in BCD)	
	0x01	-	Get currently non-selected VFOs frequency (in BCD)	
	0x00	see table2-1	Set currently selected VFOs frequency	
	0x01	see table2-1	Set currently non-selected VFOs frequency	
0x26	0x00	-	Get currently selected VFO Mode/Data/Filter (3 chars)	
	0x01	-	Get currently not-selected VFO Mode/Data/Filter (3 chars)	
	0x00	see table2-3	Set currently selected VFO Mode/Data/Filter (3 chars)	
	0x01	see table2-3	Set currently not-selected VFO Mode/Data/Filter (3 chars)	

Note as at firmware v 1.8 (12-05-2023), function 0x26/0x01 is not working correctly USB-D is reported as USB and LSB-D as LSB from the non-selected VFO. (enquiries to the currently selected VFO are working fine)

Also, it has been reported that the ATU tune action cannot be triggered via CAT if the display is turned off.



Byte 0	D(7:4)	10Hz
	D(3:0)	1Hz
Byte 1	D(7:4)	1kHz
	D(3:0)	100Hz
Byte 2	D(7:4)	100kHz
	D(3:0)	10kHz
Byte 3	D(7:4)	10MHz
	D(3:0)	1MHz
Byte 4	D(7:4)	1GHz
	D(3:0)	100MHz

Data	Mode	Comments
0x00	0x01	LSB
0x01	0x01	USB
0x02	0x01	AM
0x03	0x01	CW

Notes: 1. The second byte (filter bandwidth) has to be included in the command but is ignored and 0x01 is used.
2. Data modes LSB-D and USB-D return the same codes as LSB and USB (use command 26 if you want to see or switch to a data mode).

Data	Mode	Comments
0x00 0x00	0x01	LSB
0x00 0x01	0x01	LSB-D
0x01 0x00	0x01	USB
0x01 0x01	0x01	USB-D
0x02 0x00	0x01	AM
0x03 0x00	0x01	CW

Notes: Byte 1 is MODE, Byte 2 is whether this is a data mode (01) or not (00).
Byte 3 is the filter bandwidth but is ignored and 0x01 is always used.

Although the G90 COMM connector looks the same as the ICOM Ci-V connector, there is a difference – the ICOM® connector is a 3.5mm mono connector and uses one wire for both Tx and Rx data. The XIEGU connector is a stereo plug with Rx and Tx data on separate rings of the plug.

Band Voltage Data

The ACC socket contains a “BAND” connection which indicates which band is selected by outputting a different voltage for each band. This voltage can be used to control peripherals that require automatic band switching.

Wave band	Voltage	Wave band	Voltage	Wave band	Voltage	Wave band	Voltage
1.8MHz	230mV	7MHz	920mV	18MHz	1610mV	28MHz	2300mV
3.5MHz	460mV	10MHz	1150mV	21MHz	1840mV	/	/
5.0MHz	690mV	14MHz	1380mV	24MHz	2070mV	/	/



G90 Firmware Update Instructions

The following items are needed:

- A. USB-to-Serial 3.5mm plug cable (or DE-19 unit)
- B. G90
- C. A computer running the Windows (XP/Vista/7/8/10/11) operating system
- D. A 12-15V DC power supply (capable of supplying not less than 5A)

1. Install USB-to-Serial cable:

The very first thing is to make sure that the USB-to-Serial cable is working properly with the personal computer. The first time the cable is plugged into a USB port on the computer, the operating system will search for a driver file for this new hardware and automatically install the driver program. If all has gone well, we will be able to see the virtual serial port in the device manager program. If the driver file can't be automatically installed by the operating system we will need to install it manually (driver files are available from the Radioddity G90 support page).

(Note: very early Xiegu USB-to-Serial cables used the Prolific Chip (black USB plug), currently supplied cables use a chip from FTDI (Blue USB plug). You may also use the DE-19 unit – it requires the CH342 driver.)

After this action the virtual serial port and its port number will be visible in Windows Device Manager (which on my computer you will see is COM6).

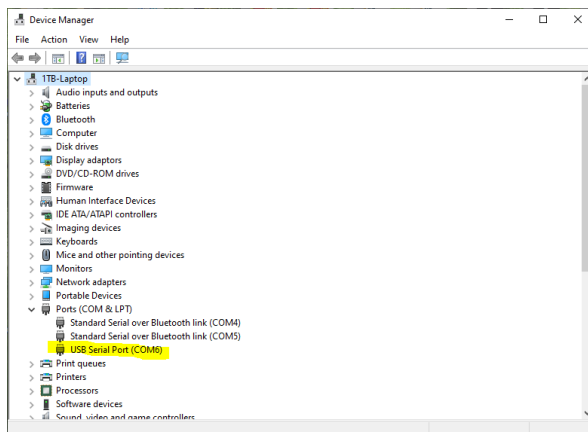



2. Wiring everything up:

2.1 Connect power cable

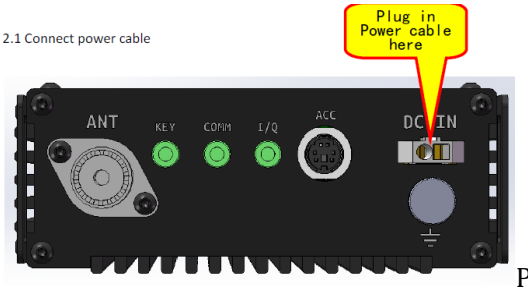

2.2 For updating the firmware in the head unit:

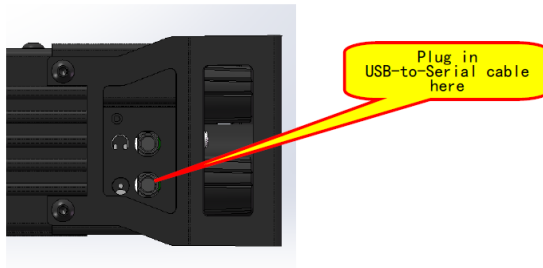

2.3 For updating the firmware in the base unit:





3. Update firmware via TeraTerm terminal software

(The program is supplied in firmware zip file from Radioddity if you don't already have it installed):

In order to transfer the firmware to the device, we use a serial terminal software program with XModem support called TeraTerm. (other programs can be used but this documentation is for TeraTerm).

3.1 Configuration of TeraTerm

a) Select the serial port:

From the upper bar, select File/New Connection and then when the panel opens, the serial radio button.

This is where we enter the com port (COM6 in my case, yours could be different) which we saw in Device manager earlier – select it from the list of available ports from the drop-down list.

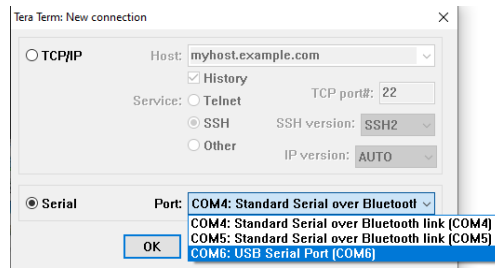

b) Now we set the communications baud rate:

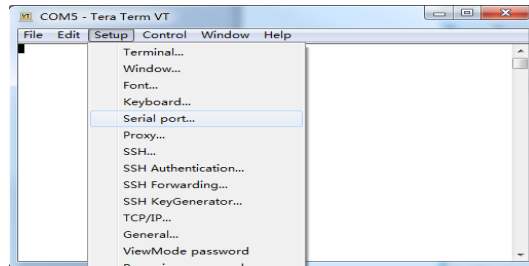

Select Setup/Serial port.

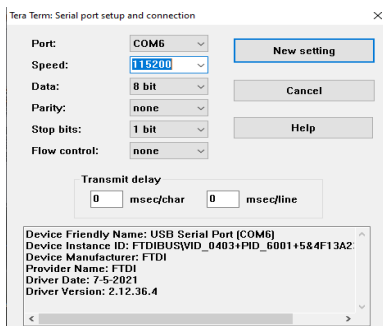

Click on **Baud rate** and from the drop-down list select **115200**, then click **New Setting**

c) We are now presented with the main terminal window:

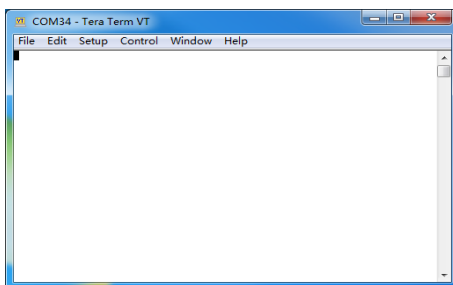

d) Now we start the G90 and want to enter the maintenance menu:

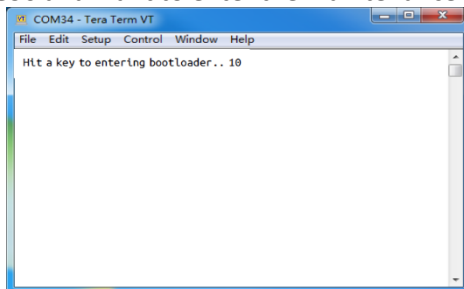

If updating from an early version of firmware to the current version press the space bar within the first 10 seconds of the start-up. If a normal boot occurs try again with the space bar on the computer held down and with the terminal program “having focus” i.e. selected.

If updating from a recent version of firmware Press the volume button on the radio as you turn the radio on. Again, if this fails, try the process holding the space



bar down and powering the G90 on.

Both of these actions interrupt the normal booting procedure and present you with a menu as shown below.

e) The firmware update menu will appear:

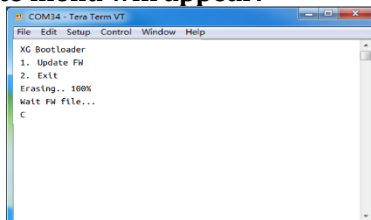

(When updating the main unit, there is a count-down timeout during which time you need to press 1 – when updating the display unit, there is no timeout, it waits for you).

Step1: Press 1

Step2: “Erasing.. 100%” and “Wait FW file...” will be displayed – the old firmware in the radio has now been erased and the menu is waiting for you to supply the new firmware code.

f) In TeraTerm select the file transfer mode and the firmware file:

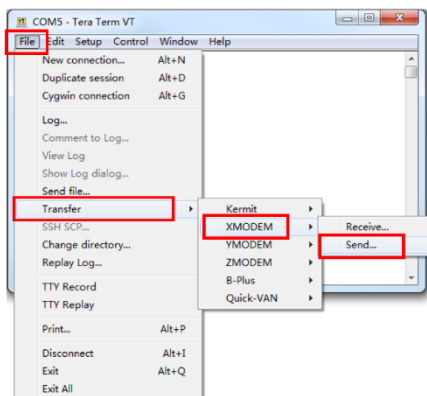

Click **File / Transfer / XMODEM / Send ...**

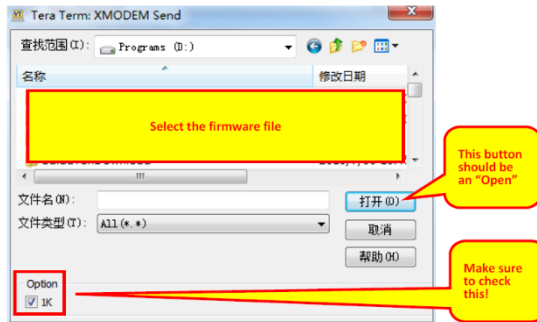

Check **1K option checkbox**.

Browse and select your new firmware file, and click the “Open” button.

g) The transfer will start

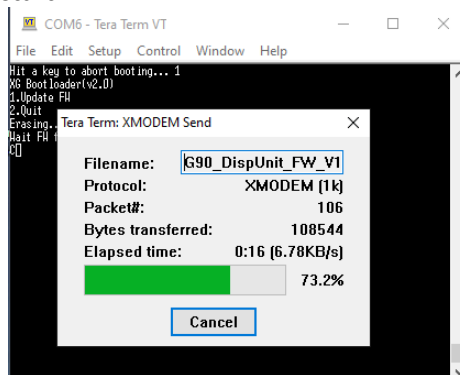

h) Wait until the transfer finishes

Once the transfer has successfully completed the G90 will restart automatically. If you need to update both parts of the radio (head and main units) – then repeat the process from step 2 above.

i) After restarting the radio, check the firmware levels through option 10 in the system menu.



Firmware upgrades list

Xiegu regularly releases firmware updates for the G90/S. Please go to radioddity.com and follow the Support link. *All information for updating your G90/S will be there including a separate step-by-step document "G90 FW Update Instructions(EN)" (as of 2023, this is also posted as a web page on the Radioddity.com website).*

The USB cable for performing updates is included with the G90/S or you can perform the upgrade via the (optional) DE-19 unit. Be sure to install the appropriate driver from the Radioddity website on your PC **before** inserting the USB cable into your PC.

WARNING! When using the simple USB-Serial lead for connectivity between PC and radio, turning the radio on with the cable plugged into either the 3.5mm COMM sockets (in the head or main unit), can cause the radio to think you wish to update the firmware and you will have a radio that is non-operative and will have to perform a firmware update before you can use the radio again!! This problem does not occur when using the DE-19.

Here is a list of the most recent improvements in the radio's firmware:

What's new in v1.8 (12th May 2023)

UPDATE DISP UNIT ONLY!!

1. To work with JTDX/WSJTX (or some other data mode software), added CI-V commands 0x25,0x26.
2. Add CI-V command 0x1d/0x19, read the XIEGU RADIO ID.

What's new in v1.79b03 (26th October 2022)

Changes:

1. Fix AM/NFM filter issue
2. New colour map for waterfall



What's new in v1.79b02 (14th October 2022)

1. Improved the AGC algorithm.
2. Improved the Filter's algorithms.

Additional functions/improvements:

1. New data mode: U-D; L-D, for USB DIG; LSB DIG,
In data mode: ACC port LINE IN is selected as audio in and the hand mic is muted; LINE OUT via the ACC socket is enabled
2. The band-pass filter is changed to allow 2 BPF defaults that can be switched between. The default values of each filter by mode are:

Mode	BPF1	BPF2	Bandwidth (kHz)
SSB	300 ~ 3000	300 ~ 3000	2700
SSB DIG	100 ~ 3100	100 ~ 3100	3000
CW	-250 ~ 250	-250 ~ 250	500
AM	-3000 ~ 3000	-3000 ~ 3000	6000
NFM	-4500 ~ 4500	-4500 ~ 4500	9000

Note: Negative numbers for frequency indicate that the frequency being used is to the left of the center of the spectrum (i.e. the lower sideband).

4. When in any secondary menu the "FUNC" key now acts as a cancel button and the secondary menu will be exited without saving any data.
5. FFT SCALE option is now fixed to AUTO
6. Optimized the FFT automatic level algorithm, so that the visual effect is smoother

What's new in v1.78b01 (20th January 2022)

This is an update to both the Main Unit and the Display Unit

File: G90_MainUnit_FW_V1.78b01

1. Fine tuning of AGC algorithm to improve audio quality
2. Fix some issues of ALC algorithm
 - 2.1 Tx power indicated more accurately
 - 2.2 Fix the issue that ATU inaccurate or fails to tune due to the instability of ALC algorithm
3. AM Tx power equal to set power
4. Display ALC level range as 0-100,

Tips:

- 4.1 If ALC level is 0: you're over driving, reduce the input signal level.
- 4.2 If ALC level is 100: you're under driving, increase input signal level
- 4.3 When doing Digi-modes, the audio baseband signals are almost of



a constant amplitude, adjust the soundcard volume to set ALC level between 20 and 80 to get good linearity

5. Fixed a built-in keyer bug (had the chance of losing dot/dash when performing squeeze operation)

File: G90_**DispUnit_FW_V1.78b01**

1. Add CI-V command for ATU operation

What's new in v1.78b (31st December 2021)

This is an update only to the Main Unit - the Display Unit firmware should have v 1.77b from March 2021 loaded.

- Added the receiving audio Modification filter to improve the sound quality and suppress high-frequency noise components.
- Improved the AGC algorithm to eliminate the spike noise caused by it.
- Improved the granularity of volume adjustment, the volume value of 0-26 is increased in steps of 1dB, and the volume value of 27-36 are increased in steps of 2dB.
- The updated version numbers should be as follows (check item 10 in the system menu):

BASE: 1.78

Dec 31 2021,11:59:24

APP: 1.77

Mar 21 2021,15:31:07

What's new in v1.7.7b (21 March 2021)

- Improvements to the AGC algorithm.
- Improved the isolation of close to channels (increased by about 30dB).
- Eliminated the impact noise of the speaker when switching between receiving and transmitting.
- When connected to GSOC, all sounds in CW mode will be played by G90 speakers. If the modem function is turned on, the sound still will be played via the GSOC.

Compatibility with GD MCU and ST MCU

Note: G90 after the product serial number X04G211600001 must use the firmware version after V1.77 (including 1.77V), if it is updated to the firmware version before 1.77V, it may not work normally.

What's new in v1.7.5

1. New system menu operation logic, change system menu item by pressing BAND Up/Down key (Equivalent to press PREV/NEXT)



2. New Multi-Function Knob operation logic
 - Press and hold Multi-Function Knob to enter menu
 - Rotate Multi-Function Knob to choose desired function
 - Press Multi-Function Knob to save and exit menu
3. New filter Center/BW operation logic
4. Narrow FM mode is available but just for testing
5. Add RF GAIN to Multi-Function Knob function list
6. Lower CW Tone volume (-15dB lower than the original level)
7. Set Narrow FM modulation frequency deviation to about +/-3.5kHz
8. Added Narrow FM SQL

What's new in v1.7.4

1. Fixed the problem that MIC Gain is relatively high
 2. Added auto FFT scale
 3. Added background VFO frequency display function under channel mode
 4. Widened the maximum bandwidth of CW filter
 5. Optimized the filter bandwidth/center frequency point adjustment and CW Tone adjustment range under CW mode
 - If CW Tone is adjusted under CW or CWR mode, the range of CW Tone is the upper and lower limits of filter under current mode
 - If CW Tone is not adjusted under CW or CWR mode, the range of CW Tone shall be within the upper and lower limits of filter under CW and CWR mode
 6. Changed RF GAIN to directly act on receiving channel gain Adjustment range: 1~100% (default: 50%), corresponding gain (on the basis of receiving channel gain): -19.6~+20dB, step=0.4dB
 - Note: RF GAIN will influence the value of Table S and FFT
 7. Added microphone filter of SSB mode to attenuate partial low frequency component of microphone signal and improve emission efficiency
 8. Changed the color of lines in frequency spectrum picture into green and fill color into semitransparent green
 9. Optimized the encoder to prevent it from interference or impulse as the first one
 10. Optimized stack and enhanced the stability
 11. Optimized the control characteristics of AGC and ALC
 12. Fixed the bug of channel storage function
 13. Fixed the spectrum display bug during emission
 14. Fixed the bug of standing wave detection threshold
 15. Fixed the problem of interrupted voice during low power emission
- Updated version number can be checked in 10th item of system



menu. It takes about 3s to read version information once entering this item)

What's new in v1.7.3

1. Rotate encoder driver is optimized, smoother and less loss of step
2. Total RF GAIN=1/4 RF GAIN setting when AGC is off, prevent sudden volume increase
3. Rx volume step is optimized
4. Lower the MIC GAIN, prevent picking up too much background noise

What's new in v1.7.2 (experimental version)

1. CW timing is optimized, solved the issue of randomly losing DOT/DASH.
2. T/R switch timing is optimized, faster switching time ($t_c=53ms$).
3. Add ALC meter, display below the TX power meter when TXing. It is mainly for digital mode, to get the good linearity. adjust driving level or Line IN volume to make the ALC meter value within 30~90. Max level of Line IN should not be more than 600mVp-p, or it will overload the input amplifier.
4. PO meter is optimized, more accurate.
5. Rotate encoder driver is optimized, less losing of steps.
6. ACC LINE OUT is optimized, main volume will not affect its output level anymore.
7. ACC Band Voltage switching output is optimized, solved the issue of wrong voltage for 12m band.
8. TS max digit change from 10k to 100k when pushing the main knob.
9. RIT function added: Press and hold main knob to activate.

What's new in v1.7.1

1. RF Gain Control: After a long press of the AGC button. Rotate the main VFO knob to change the RF gain (this does not affect the S meter or FFT scales).
2. DSP Filter: A momentary press of the multi-function knob allows setting of the DSP center frequency and the bandwidth of the filter.
3. FFT Averaging: Pressing the FUNC button and then the LOCK button opens the setting of the averaging function. Adjust it to your personal preference.

Copyright Statement

All Rights Reserved, 2024

Chongqing Xiegu Technology Co., Ltd. reserves all rights of the manual. All parts of the manual shall not be copied without permission.

1010160204-C